

Learn to spin on an Ashford Wheel



spinning | weaving | carding | felting | knitting | dyeing

Welcome to the world of hand spinning ...

Ashford spinning wheels are designed to make spinning easy. This booklet will help you get started. There are many different ways to spin. Soon you will be developing your own style and be creating many different kinds of yarns. All Ashford spinning wheels have similar parts and function. In this booklet we use the Kiwi spinning wheel for our main spinning instructions. All other Ashford spinning wheels are featured with wheel set up pages. We use Ashford wool sliver. Other fibres such as silk, linen, cotton, and many animal fibres can also be spun on Ashford wheels.

Parts

Become familiar with the names of the parts – treadle, bobbin, flyer and whorl, spindle, orifice, flyer hooks, threading hook, drive band, brake band and tension knob, back and front support bearings, and lazy kate.

Brake Band

Turn the brake band tension knob until the springs just begin to stretch. Do not overtighten or the yarn may break and the wheel will be hard to treadle.

Drive band

Place the drive band over the largest groove on the flyer whorl and the smallest groove on the wheel.

READY TO BEGIN

You will need:

Approx. 50grams (1½ozs) of wool sliver
1.5metre (5ft) length of medium weight yarn for a leader yarn and a 10metre (30ft) length for practising
Chair
Niddy noddy

PRACTISE

Go through each step taking time to feel the rhythm of treadling and working with your hands.

Lubrication

Regularly apply a drop of oil to all points as directed in your wheel's assembly instructions.



Kiwi 3, P3



Traditional Single Drive, P11



Traditional Double Drive, P13



Joy 2, P18



Country 2, P21



Elizabeth 2, P16



Traveller Single Drive, P14



Traveller Double Drive, P15



e-Spinner, P19



e-Spinner Super Jumbo, P20

01



TREADLE: Sit on a chair in front of the wheel and place your feet on the treadles. Turn the wheel in a **CLOCKWISE** direction with your hand, and start treadling slowly. Use a heel and toe action. Stop and practise starting again until you feel comfortable treadling.

02



THE LEADER: Start by attaching the yarn to the bobbin. Attach the 1.5metre (5ft) leader yarn firmly onto the bobbin. Ensure it does not slide around the centre of the bobbin.

03



Feed the leader yarn through the black yarn guide on the left flyer arm, around the cup hook and pull it through the orifice using the threading hook. Refer to the set up page for your specific spinning wheel.

04



Hold the leader and turn the wheel clockwise 3 times. This starts the yarn winding onto the bobbin. Stop when approximately 50cm (20ins) of yarn is left in front of the orifice. Check your tension springs are not stretched out - they should be just starting to open.

05



SPINNING PRACTISE: Make a loop at the end of the yarn.

06

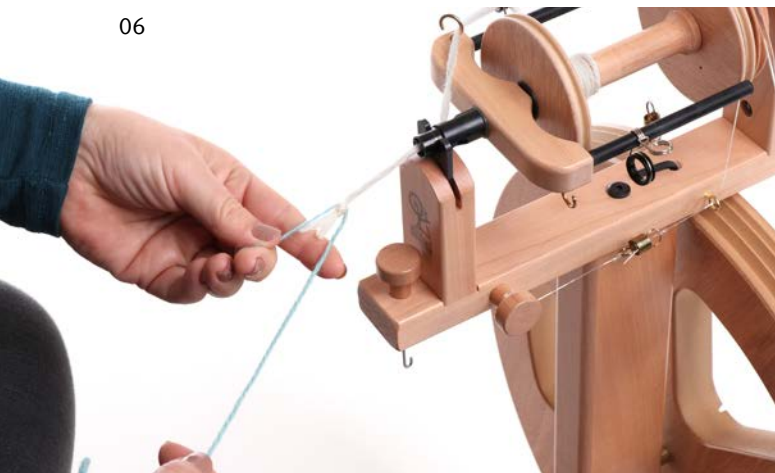

Take the practise yarn through the loop of the leader.
HANDS AND FEET: Hold the yarn at the loop with your front hand. Start treadling slowly clockwise. Allow the yarn to join onto itself. Then feed the yarn into the flyer orifice with your front hand.

07

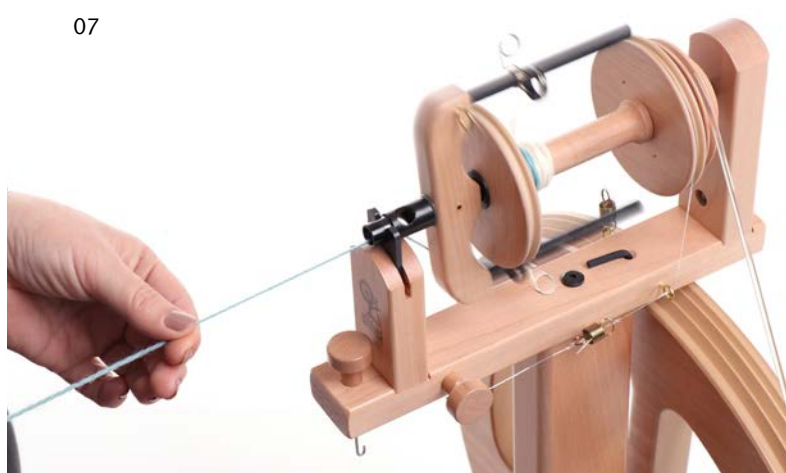

Keep treadling slowly, allowing the yarn to slide through your back hand.

PRACTISE THE DRAFTING ACTION:

1. Pinch the yarn between your index finger and thumb on your front hand.
2. Relax the pinch slightly and slide your fingers back towards you – the twist will follow.
3. Pinch again when the twist has carried down the length of the yarn.
4. Feed the yarn into the orifice and onto the bobbin. Repeat this until you come to the end of the yarn. Lift the brake band off the back of the bobbin and pull the practise yarn back through the orifice. Replace the brake band and practise the drafting action again. Once you feel your hand and foot action is coordinated you are ready to start spinning with the wool sliver.
5. If the yarn does not feed in increase the brake band tension a little. If the yarn is pulled out of your hands or breaks, reduce the brake band tension a little.

09



SPINNING: Take a length of wool sliver. Pull some fibres out of the end of the sliver.

10



Take these fibres through the loop and double back. Start treadling slowly clockwise until there is a light twist in the fibres around the leader.

11

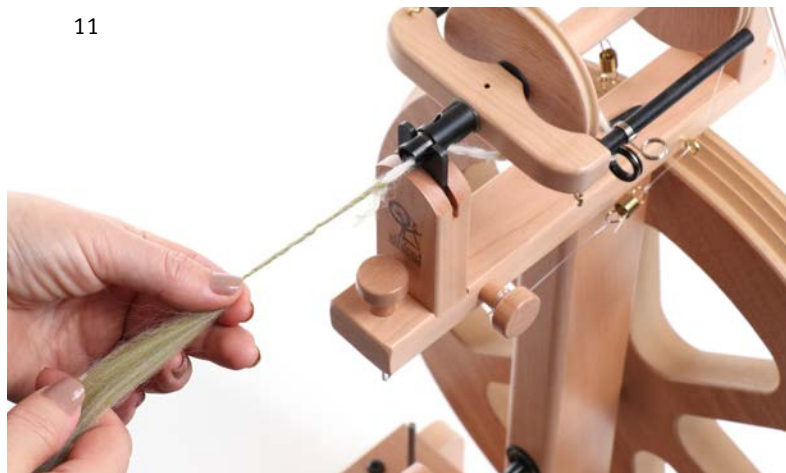

Now you are ready to begin drafting and spinning a yarn.

12

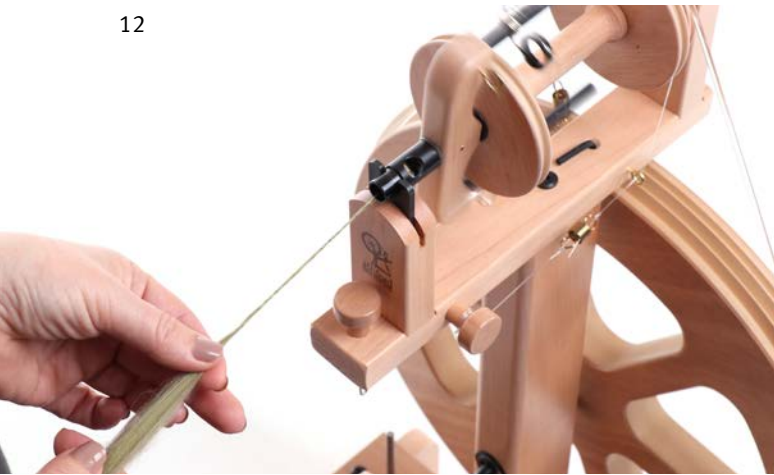

Continue treadling clockwise. Pinch the yarn with your front hand.

13

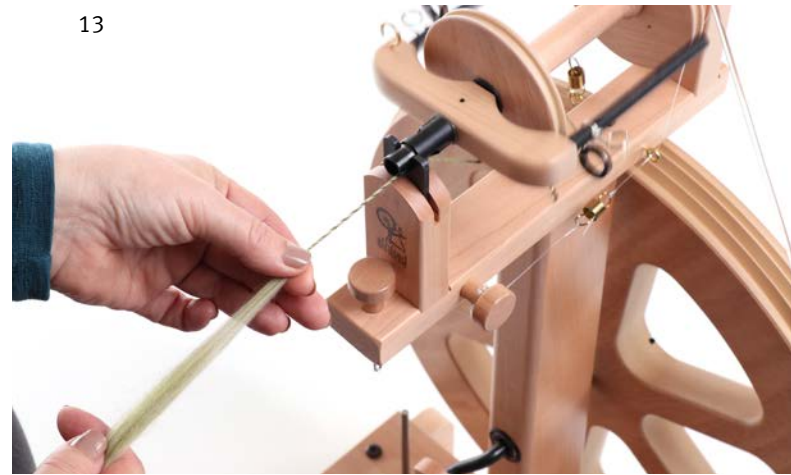

Pull the fibres gently backwards with your back hand to form the yarn. Relax the pinch slightly and slide your pinched fingers back towards you, letting the twist follow your fingers. Repeat the drafting motion - pinch, pull fibres back until you have a consistent thickness, relax fingers and slide back allowing the twist into the drafted fibres. Feed the twisted length of yarn forward into the orifice and onto the bobbin. Repeat.

14



NOTE: The pinching fingers of your front hand prevent the twist entering the undrafted sliver. If this happens stop treadling and pull the spun yarn from the sliver and start again. Hold the sliver lightly in your back hand and allow the fibres to pull out easily. This makes it easy to spin a consistent yarn.

15



NOTE: Think about the staple length of the fibre you are spinning, do not draft longer than the staple length. Relax the back hand and allow the fibres to flow.



16

JOINING THE YARN: Treadle slowly clockwise and hold the spun yarn in your front hand. Place more sliver alongside. Allow the fibres to catch and twist into the yarn.



17

Pinch the fingers of your front hand in front of the join and start drafting the fibres again.



18

FILLING THE BOBBIN: As the yarn builds up on the bobbin stop spinning, squeeze the yarn guide and slide it along a little. Do this often working backwards and forwards along the length until the bobbin is full. When treadling faster it may be necessary to move the opposite yarn guide as well to ensure perfect flyer balance.

HINTS FOR THIS STAGE:

1. Do not sit too close to the wheel. Relax, lean back and leave room for your hands to work.
2. Uneven yarn is OK - your first handspun will be a beautiful "fancy yarn".
3. You can vary the amount of twist in your yarn by changing the speed of your treadling or hand movements.
4. A fine yarn needs more twist than a thick yarn to make it strong.
5. Move the yarn guides along the flyer as you fill the bobbin.
6. Slightly tighten the brake band as the bobbin fills.

19



CHANGING THE BOBBIN – remove the drive band (place on the rear upright). Unhook the brake band and remove from the bobbin. Hold the front of the flyer and click up and just out of the front bearing. Pull the flyer towards you to remove from the rear bearing.

20



With your thumb pushing up on the end of the bobbin pull the whorl off the other end. Change bobbin, replace whorl, place back into rear bearing and click back down into the front bearing. Replace the brake band and drive band, check drive band is aligned correctly with the wheel.

21



PLYING: We recommend you ply two single yarns together to make a strong, balanced 2 ply yarn. Place 2 full bobbins onto the built-in lazy kate. Place an empty bobbin on the flyer. Attach a leader yarn with a loop and pull it through the orifice as before.

22



Take 1 yarn from each bobbin, put them through the loop and double back about 10cm (4ins).

23

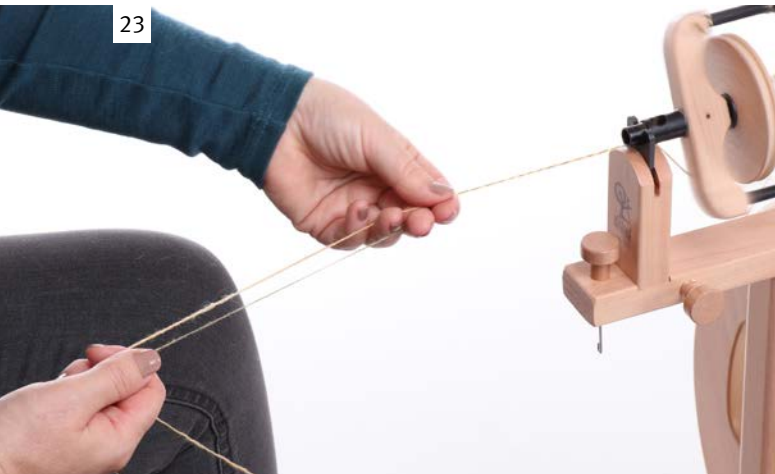

Begin treadling slowly in an ANTI-CLOCKWISE direction. Use your fingers to separate the 2 singles before they twist together. Pinch the yarn with your front hand.

24



Relax the pinch slightly and slide your fingers back towards you. The twist will follow. Pinch again and feed the plied yarn into the orifice and onto the bobbin.

25



Repeat until you have a full bobbin.

Check!

- The whorl is pushed fully onto the flyer shaft. If not this can cause the flyer assembly to be tight between the bearings.
- The front of the flyer is snapped down into the front flyer bearing.
- That both the bobbin and flyer have end play and spin freely. If not ensure the rear flyer nylon bearing has been tapped fully to the bottom of the hole in the upright.
- The brake band only has sufficient tension to draw the yarn onto the bobbin. The springs should only just be starting to stretch.
- That the drive belt is correctly aligned in the grooves in the wheel and whorl.
- Apply a drop of oil to the oiling points indicated in the assembly instructions.
- When not using your Kiwi 3 release the tension on the drive band by moving it down one step on the whorl or wheel.

For additional troubleshooting refer to page 22.

26

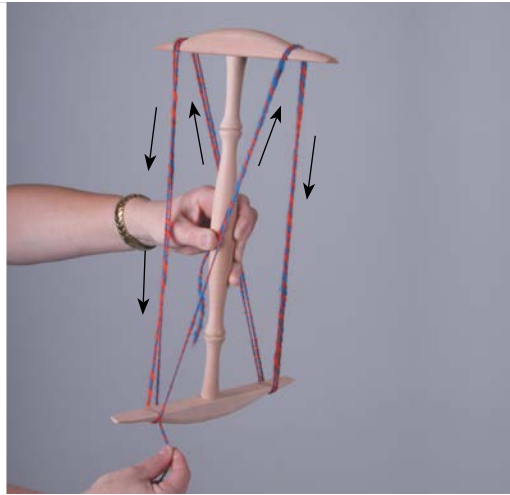
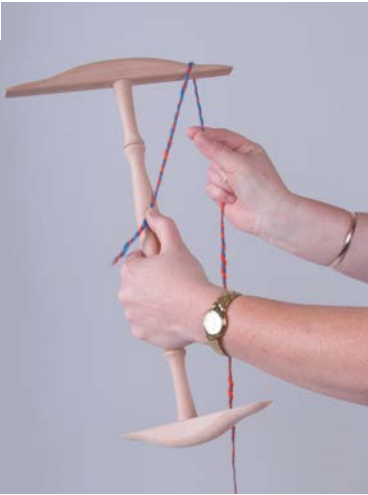

MAKING A SKEIN: When the bobbin of plied yarn is full you are ready to make a hank. Loosen the brake or drive band. Hold the yarn in the centre of the niddy niddy with your thumb. Wind the yarn over the upper cross piece and under the lower cross piece as shown. Repeat until all the yarn is on the niddy niddy.

27



Take 4 short lengths of scrap yarn and tie the yarn at the centre on 4 sides.

28



Remove the yarn from the niddy niddy. Now you have your first hank. Twist into a skein of your own unique handspun yarn!

TRADITIONAL SINGLE DRIVE

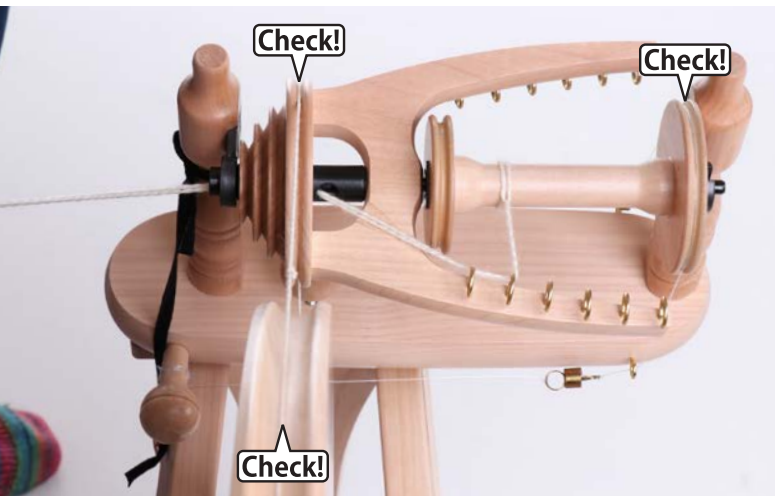

The flyer is driven by the drive band and the yarn pulls the bobbin around. The brake band is used to slow the bobbin slightly.

THE LEADER: Start with a leader yarn on the bobbin. Attach a 1.5metre (5ft) leader yarn firmly onto the bobbin. Ensure it does not slide around the centre of the bobbin. Place the leader yarn over the hook near the orifice and then thread through the orifice using the threading hook. Make a loop at the end of the leader.

Check!

- The drive band lines up with the largest whorl on the flyer.
- Place the brake band over the bobbin. The springs should only be just starting to expand.
- The nylon bearings on the maid uprights are perpendicular to the flyer - not turned inwards or outwards.
- Ensure you have oiled the flyer and bobbin bearings as indicated in the assembly instructions.

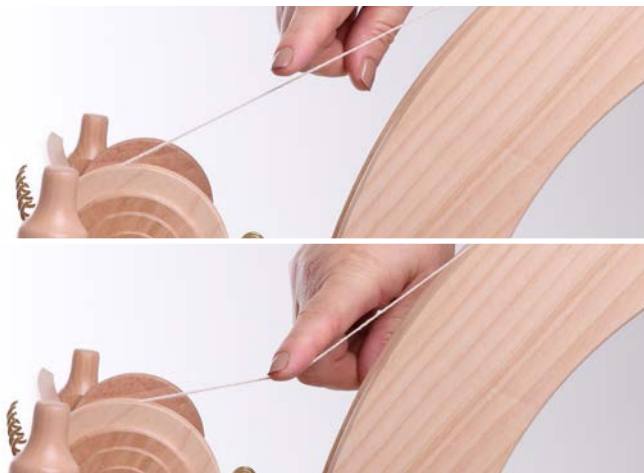

Check the drive band is not too tight. You only need enough tension on the drive band to make the flyer go around when treadling. If your drive band is too tight it will be harder to treadle.



To change to a faster ratio, move the drive band over to a smaller groove on the whorl and adjust the drive band tension by turning the adjusting knob to raise the maiden bar. You may need to realign the maiden bar by loosening the screws underneath and sliding it across so the groove in the whorl aligns with the groove in the wheel. Then retighten the screws.

Traditional single drive continued...

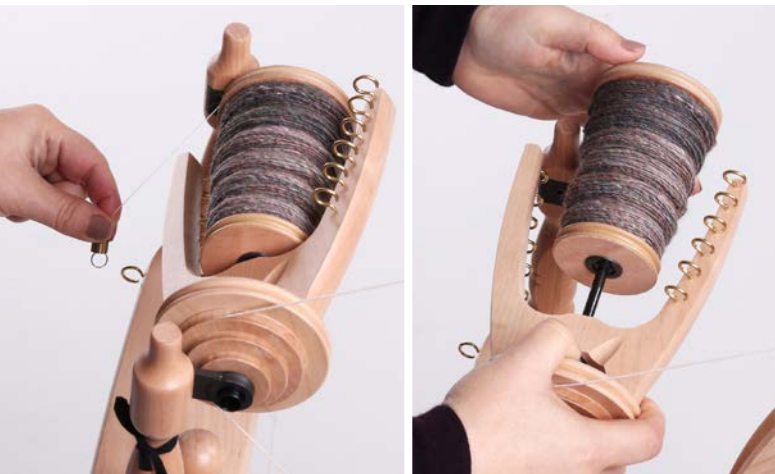

CHANGE THE BOBBIN: Unhook the brake band and remove from the bobbin end. Turn the front maiden upright slightly outwards and click the end of the flyer shaft out of the rear flyer bearing. Slide the full bobbin off and place the empty bobbin on, small end first. Click the flyer shaft back into the rear flyer bearing. Check the front maiden upright is at right angles to the flyer shaft. Replace the brake band over the bobbin end and connect to the cup hook.

Check!

- The maid uprights are at right angles to the flyer shaft to ensure the flyer spins freely.
- That both the bobbin and flyer have end play and spin freely. Apply a drop of oil to the oiling points indicated in the assembly instructions.
- The whorl groove you are using is aligned with the wheel to ensure the drive band doesn't rub on the side of the whorl. If necessary loosen the screws under the maiden bar, align and tighten.
- The maiden bar is tilted forward towards the wheel to help minimise any vibration. If necessary shorten and retie the drive band.
- The drive band only has sufficient tension to turn the flyer. Too much tension adds unnecessary bearing friction and will make treadling harder. Loosen or tighten by turning the adjusting knob.
- The brake band only has sufficient tension to draw the yarn onto the bobbin. The springs should only just be starting to stretch.
- The wheel spins freely, the single leg is centralised and the 4 bolts are tight.

For additional troubleshooting refer to page 22.

TRADITIONAL DOUBLE DRIVE

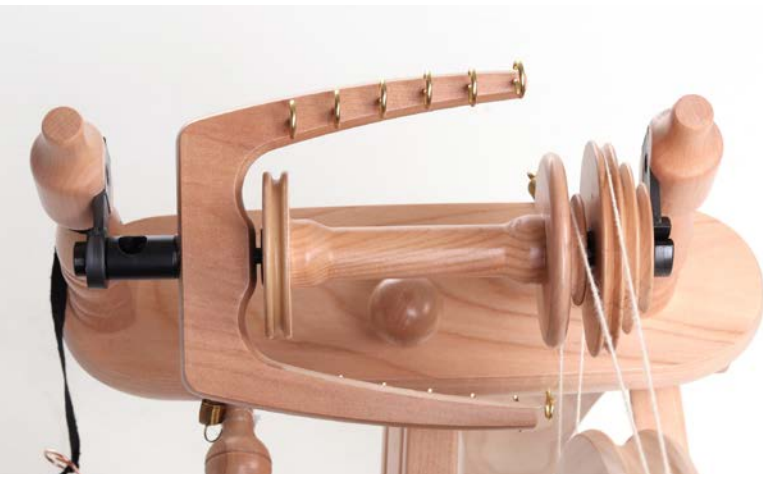

The drive band drives both the flyer and bobbin. As the flyer and the bobbin have different size whorls they are driven at different speeds.

Wrap the drive band around the groove in the wheel, around the large flyer whorl, back around the wheel and around the bobbin whorl.

See page 17 to convert to single drive.



THE LEADER: Start with a leader yarn on the bobbin. Attach a 1.5metre (5ft) leader yarn firmly onto the bobbin. Ensure it does not slide around the centre of the bobbin.

Place the leader yarn over the hook near the orifice and then thread through the orifice using the threading hook. Make a loop at the end of the leader.

Check!

- The whorl is pushed fully onto the flyer shaft. If not this can cause the flyer assembly to be tight between the bearings.
- The bobbin is the correct way around with the small bobbin whorl beside the flyer whorl. For Double Drive the drive band is on both the bobbin whorl and flyer whorl. For Single Drive the drive band is only on the flyer whorl and the brake band is on the bobbin whorl. *See page 17.*
- That both the bobbin and flyer have end play and spin freely.
- Check the drive band is not too tight. You only need enough tension on the drive band to make the flyer go around when treadling. If your drive band is too tight it will be harder to treadle.
- Apply a drop of oil to the oiling points indicated in the assembly instructions.
- If the yarn does not feed in, increase the drive band tension. If the yarn is pulled out of your hands or breaks reduce the drive band tension.



CHANGE THE BOBBIN: Turn the front maiden upright slightly outwards and click the end of the whorl out of the rear flyer bearing. With your thumb pushing up on the end of the bobbin, pull the whorl off the other end. Change the bobbin, replace the whorl and drive band back into the rear bearing and click back down. Check the front maiden upright is at right angles to the flyer shaft and the drive band is aligned.

For additional troubleshooting refer to page 22.

TRAVELLER SINGLE DRIVE



The flyer is driven by the drive band and the yarn pulls the bobbin around. The brake band is used to slow the bobbin slightly.

THE LEADER: Start with a leader yarn on the bobbin. Attach a 1.5metre (5ft) leader yarn firmly onto the bobbin. Ensure it does not slide around the centre of the bobbin. Place the leader yarn over the hook near the orifice and then thread through the orifice using the threading hook. Make a loop at the end of the leader.

Check!

- The bobbin spins freely on the flyer shaft.
- The maid uprights are at right angles to the flyer shaft to ensure the flyer spins freely.
- That both the bobbin and flyer have end play and spin freely. Apply a drop of oil to the oiling points indicated in the assembly instructions.
- The whorl groove you are using is aligned with the wheel to ensure the drive band doesn't rub on the side of the whorl. If necessary loosen the screws under the maiden bar, align and tighten.
- The maiden bar is tilted forward towards the wheel to help minimise any vibration. Shorten and retie the drive band.
- The drive band only has sufficient tension to turn the flyer. Too much tension adds unnecessary bearing friction and will make treadling harder. Loosen or tighten by turning the adjusting knob.
- That all 4 legs are fully into the holes in the base and the spinning wheel sits evenly on the floor.
- The wheel sits evenly between the sides of the base. If necessary loosen the bolts holding the wheel supports, twist and tighten.
- The wheel spins freely and the bolts holding all 4 uprights to the base are tight.



Check the drive band is not too tight. You only need enough tension on the drive band to make the flyer go around when treadling. If your drive band is too tight it will be harder to treadle.

For additional troubleshooting refer to page 22.

TRAVELLER DOUBLE DRIVE



The drive band drives both the flyer and bobbin. As the flyer and the bobbin have different size whorls they are driven at different speeds.

Wrap the drive band around the groove in the drive wheel, around the large flyer whorl, back around the wheel and around the bobbin whorl.

See page 17 to convert to single drive.

THE LEADER: Start with a leader yarn on the bobbin. Attach a 1.5metre (5ft) leader yarn firmly onto the bobbin. Ensure it does not slide around the centre of the bobbin.

Place the leader yarn over the hook near the orifice and then thread through the orifice using the threading hook. Make a loop at the end of the leader.

Check!

- The whorl is pushed fully onto the flyer shaft. If not this can cause the flyer assembly to be tight between the bearings.
- The bobbin is the correct way around with the small bobbin whorl beside the flyer whorl. For Double Drive the drive band is on both the bobbin whorl and flyer whorl. For Single Drive the drive band is on the flyer whorl and the brake band is on the bobbin whorl. *See page 17.*
- That both the bobbin and flyer have end play and spin freely.
- Check the drive band is not too tight. You only need enough tension on the drive band to make the flyer go around when treadling. If your drive band is too tight it will be harder to treadle.
- Apply a drop of oil to the oiling points indicated in the assembly instructions.
- If the yarn does not feed in, increase the drive band tension. If the yarn is pulled out of your hands or breaks reduce the drive band tension.



For additional troubleshooting refer to page 22.

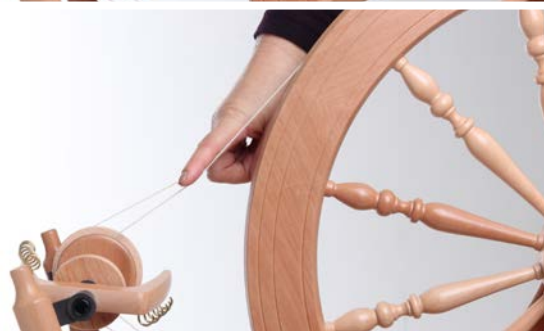

Check the drive band is not too tight. You only need enough tension on the drive band to make the flyer go around when treading. If your drive band is too tight it will be harder to treadle.

The drive band drives both the flyer and bobbin. As the flyer and the bobbin have different size whorls they are driven at different speeds.

Wrap the drive band around the groove in the drive wheel, around the large flyer whorl, back around the wheel and around the bobbin whorl.

THE LEADER: Start with a leader yarn on the bobbin. Attach a 1.5metre (5ft) leader yarn firmly onto the bobbin. Ensure it does not slide around the centre of the bobbin.

Place the leader yarn over the hook near the orifice and then thread through the orifice using the threading hook. Make a loop at the end of the leader.

Check!

- The whorl is pushed fully onto the flyer shaft. If not, this can cause the flyer assembly to be tight between the bearings.
- The maid uprights are at right angles to the flyer shaft to ensure the flyer spins freely.
- That both the bobbin and flyer have end play and spin freely.
- The whorl groove you are using is aligned with the wheel to ensure the drive band doesn't rub on the side of the whorl. If necessary loosen the screws under the maiden bar, align and tighten.
- The bobbin is the correct way around with the small bobbin whorl beside the flyer whorl. For Double Drive the drive band is on both the bobbin whorl and flyer whorl. For Single Drive the drive band is only on the flyer whorl and the brake band is on the bobbin whorl. *See page 17.*
- The drive band only has sufficient tension to turn the flyer. Too much tension adds unnecessary bearing friction and will make treading harder. Loosen or tighten by turning the adjusting knob.
- When spinning single drive the brake band only has sufficient tension to draw the yarn onto the bobbin. The springs should only just be starting to stretch.
- The wheel sits evenly above the base and spins freely. If necessary loosen the bolts holding the wheel supports, twist and tighten.
- Apply a drop of oil to the oiling points indicated in the assembly instructions.

For additional troubleshooting refer to the back of this booklet.



CONVERTING YOUR DOUBLE DRIVE WHEEL TO SINGLE DRIVE: The double drive Traditional, Traveller and Elizabeth 2 spinning wheels have both single and double drive options. When spinning single drive loosen the drive band tension and place both drive bands over the whorl. Check the drive band tension. Place the brake band over the bobbin whorl and turn the brake band tension knob until the springs just begin to stretch.

NOTE: The brake band is not required when spinning double drive.

JOY 2 SPINNING WHEEL



THE LEADER: Start with a leader yarn on the bobbin. Attach a 1.5metre (5ft) leader yarn firmly onto the bobbin. Ensure it does not slide around the centre of the bobbin. Take the leader yarn through the black yarn guide on the right flyer arm, around the cup hook and through the orifice using the threading hook.



When attaching the flyer hold the whorl in one hand and screw the flyer in with the other hand.

NOTE: Avoid getting oil on the thread at the end of the flyer shaft or in the hole it screws into.

Check!

- That the metal stays attached to the treadle base are fully locked down. This ensures the wheel sits flat on the floor.
- Loosen and tighten the flyer by holding the whorl and turning the flyer.
- The bobbin has end play and spins freely.
- The drive belt is correctly aligned in the grooves in the wheel and whorl.
- Always use the built-in handle to lift the spinning wheel. Never lift the wheel by the flyer. Always remove and store the flyer in the frame when transporting it.
- The brake band only has sufficient tension to draw the yarn onto the bobbin. The springs should only just be starting to stretch.
- Apply a drop of oil to the oiling points indicated in the assembly instructions.
- When not using your Joy release the tension on the drive band by moving it down one step on the flyer or wheel.

For additional troubleshooting refer to page 22.

e-SPINNER 3

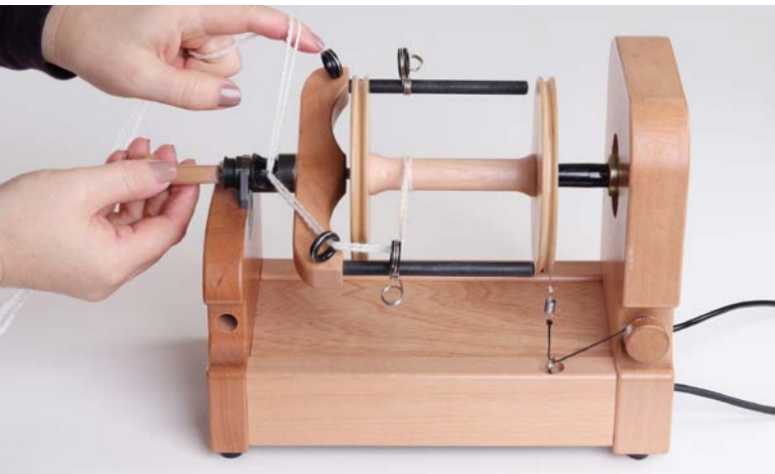

THE LEADER: Start with a leader yarn on the bobbin. Attach a 1.5metre (5ft) leader yarn firmly onto the bobbin. Ensure it does not slide around the centre of the bobbin.

Take the leader yarn through the flyer yarn guides with the black inserts on the right-hand side of the flyer and out through the orifice using the threading hook.

SPINNING: The flyer will start to rotate when the speed dial reaches approximately 10 o'clock. This is normal. Begin slowly and increase speed once spinning. Remember to “feed” the yarn onto the bobbin. When spinning thick yarns you require less twist so reduce speed. When the yarn overtwists it will not feed on.

Check!

- The front of the flyer is snapped down into the front flyer bearing.
- That both the bobbin and flyer have end play and spin freely. Apply a drop of oil to the oiling points indicated in the assembly instructions.
- The brake band only has sufficient tension to draw the yarn onto the bobbin. The springs should only just be starting to stretch.
- The yarn guides are opposite each other when spinning at higher speeds to ensure perfect balance.

FOOT SWITCH

If you would like to START and STOP your e-Spinner 3 with the foot switch only, insert the foot switch plug into the FOOT SWITCH hole at back of the e-Spinner. There are two operating modes.

On/Off Mode

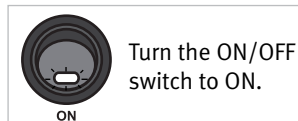

Lightly tap the foot switch to turn the e-Spinner 3 ON and lightly tap again to turn it OFF.

START

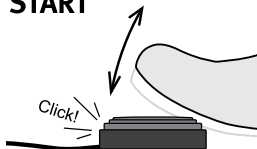

STOP

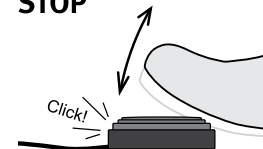

Hold Down Mode

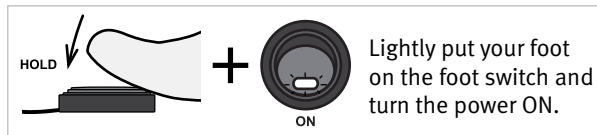

ON

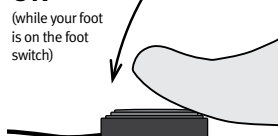

OFF



The e-Spinner 3 will operate only while your foot is on the foot switch. Lift your foot off and the e-Spinner 3 will stop.

e-SPINNER SUPER JUMBO



THE LEADER: Start with a leader yarn on the bobbin. Attach a 1.5metre (5ft) leader yarn firmly onto the bobbin. Ensure it does not slide around the centre of the bobbin. Take the leader yarn through the flyer yarn guides with the black inserts on the left-hand side of the flyer and out through the orifice using the threading hook.

SPINNING: The flyer will start to rotate when the speed dial reaches approximately 10 o'clock. This is normal. Begin slowly and increase speed once spinning. Keep the leather brake band loose as very little tension is required to draw the yarn onto the bobbin. Remember to “feed” the yarn onto the bobbin. When spinning thick yarns you require less twist so reduce speed and work near the orifice “feeding” the yarn on frequently. When the yarn overtwists it will not feed on. When spinning finer yarns insert the reducer bushes into the orifice.

Check!

- That both the bobbin and flyer have end play and spin freely. Apply a drop of oil to the oiling points indicated in the assembly instructions.
- The leather brake band is loose as very little tension is required to draw the yarn onto the bobbin. Apply a drop of oil under the leather if necessary.
- The yarn guides are opposite each other when spinning at higher speeds to ensure perfect balance.
- The drive belt is correctly positioned in the middle grooves in the bobbin whorl.
- When not using your e-Spinner Super Jumbo, release the tension on the drive band by moving it down one step on the bobbin whorl.

FOOT SWITCH

If you would like to START and STOP your e-Spinner Super Jumbo with the foot switch only, insert the foot switch plug into the FOOT SWITCH hole under the e-Spinner. There are two operating modes.

On/Off Mode



Turn the ON/OFF switch to ON.

START

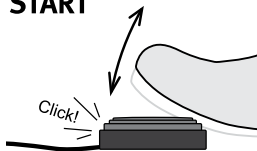

STOP

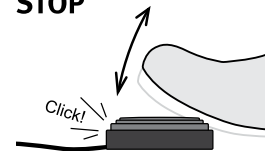

Lightly tap the foot switch to turn the e-Spinner ON and lightly tap again to turn it OFF.

Hold Down Mode

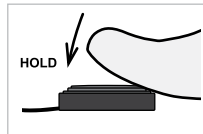

+



Lightly put your foot on the foot switch and turn the power ON.

ON

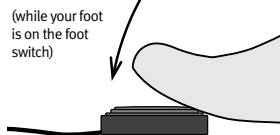

OFF



The e-Spinner will operate only while your foot is on the foot switch. Lift your foot off and the e-Spinner will stop.

COUNTRY SPINNER 2



THE LEADER: Start with a leader yarn on the bobbin. Attach a 1.5metre (5ft) leader yarn firmly onto the bobbin. Ensure it does not slide around the centre of the bobbin.

Take the leader yarn through the flyer yarn guides with the black inserts on the left-hand side of the flyer and out through the orifice.



SPINNING: Keep the leather brake band loose. Too much tension will make it very harder to treadle.

Remember to “feed” the yarn onto the bobbin.

When spinning thick yarns you require less twist so treadle very slowly and work near the orifice “feeding” the yarn on frequently. When the yarn overtwists it will not feed on.

Check!

- That both the bobbin and flyer have end play and spin freely. If not adjust the front and rear top rails. Apply a drop of oil to the oiling points indicated in the assembly instructions.
- The leather brake band is loose as very little tension is required to draw the yarn onto the bobbin. Apply a drop of oil under the leather.
- The drive belt is correctly aligned in the grooves in the wheel and whorl.
- When not using your Country Spinner 2 release the tension on the drive band by moving it down one step on the flyer or wheel.



For additional troubleshooting refer to page 22.

TROUBLESHOOTING

1. What do I do to prevent the yarn being pulled out of my hands?

A. Single drive

- › Reduce the brake band tension until the springs are just starting to extend.

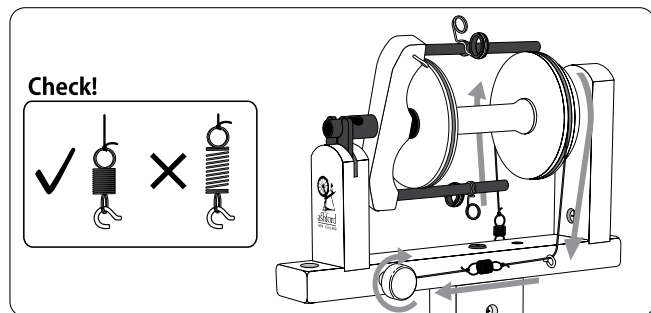

- › Check the bobbin whorl is smooth. If necessary smooth with sandpaper.
- › Apply a drop of oil to the bobbin whorl.

B. Double Drive

- › Reduce the drive belt tension.

2. What do I do if the yarn won't draw in?

- › Increase the brake band tension.
- › Ensure the bobbin rotates freely on the flyer shaft.
- › Check the flyer hooks are smooth and are not catching the yarn.
- › Check the orifice and exit hole are clear.

3. What do I do if the wheel is hard to treadle?

- › Reduce the drive band tension, it should have about 25mm (1in) of "bounce" in it.

4. What do I do if the yarn is overtwisting and not feeding on?

- › Overtwisted yarn will not "feed on" to the bobbin. Reduce the speed at which you are treadling or increase the speed of your drafting and feeding. A comfortable wheel speed is 60RPM.

5. What do I do if the yarn is not feeding on?

- › Check it is not caught on or twisted around any hooks.

6. What do I do if the flyer is not turning freely?

- › Check the flyer bearings are at right angles to the flyer shaft and not turned in jamming the flyer.

A. Single drive

- › Check the brake band is over the bobbin whorl and the springs are just starting to extend.

B. Double drive

- › Check the drive band is around the small whorl on the bobbin and the largest flyer whorl.
- › Check there is sufficient tension on the drive band.
- › Check the whorl is pushed completely on.

7. How much tension should I have on the drive band?

- › Only have sufficient tension to drive the flyer and bobbin without slipping. Too much tension makes treadling harder.
- › Generally the drive band should be able to be easily depressed about 25mm (1in). Turn the drive band adjusting knob until you have the correct tension.
- › If the drive band has stretched, shorten and retie it or replace it.

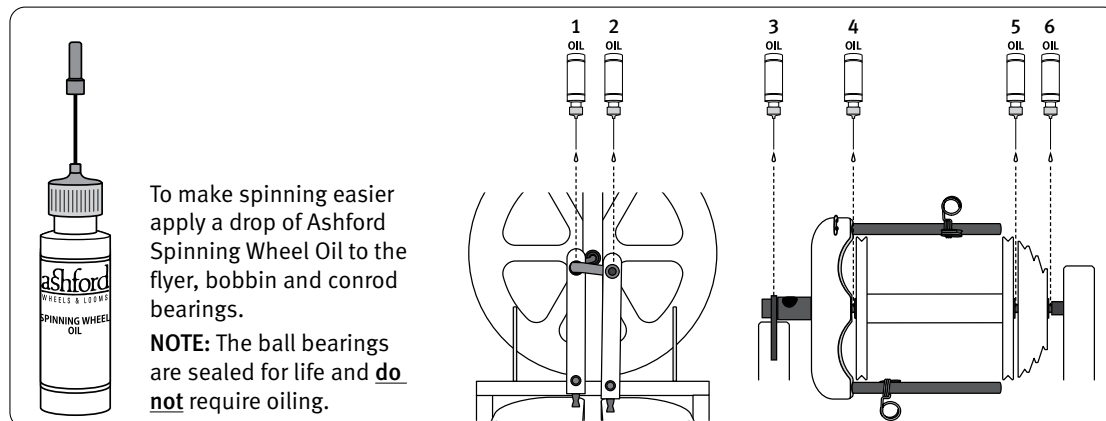

8. Why use two tension springs on the brake band?

- › Two springs fitted either side of the bobbin whorl will make plying easier as it allows the brake band to flex rather than pull against the tension knob. Spare springs are available from your Ashford dealer.

9. How do I avoid my yarn getting overtisted?

- › Put the drive band onto a larger flyer whorl.
- › Treadle slower. Around 60 RPM is a nice easy speed.
- › Draft your yarn faster. This may require you to better prepare your fibre prior to spinning.

10. How do I avoid my yarn breaking?

- › Make your yarn stronger by treadling a little faster.
- › Draft more fibres to make the yarn a little thicker.
- › Pinch and slide your fingers along the spun yarn so you are always in contact with the yarn. This also prevents the 'twist' entering the undrafted fibres.

11. How do I prevent my spinning wheel walking away from me?

- › Check the wheel is free running.
- › Treadle with a downwards action rather than away from you.
- › Spin with your wheel on carpet or a rug.

12. What is the best finish for my spinning wheel?

- › Our spinning wheels are made from Beech timber, sourced from sustainably managed forests. If your wheel is natural timber it should be protected as soon as possible to avoid staining and provide protection from any climatic changes. We recommend Ashford Finishing Wax Polish, however any reputable wood oil or wax finish would be suitable. Factory lacquered wheels may be further enhanced with our Finishing Wax Polish.

SPINNING TOOLS

Recommended accessories



maintenance kit



jumbo flyers



finishing wax polish



skeiner



niddy noddies



spinning chair



handcarders



flick carder

For more information on hand spinning techniques see *The Ashford Book of Hand Spinning*, by Jo Reeve.

The Ashford Book of Hand Spinning
– By Jo Reeve



For more information, helpful hints and inspiration we recommend The Ashford Book of Hand Spinning. Visit our website to view our tutorial videos www.ashford.co.nz



Ashford Handicrafts Limited
415 West Street, PO Box 474, Ashburton, New Zealand
Ph +64 3 308 9087 sales@ashford.co.nz www.ashford.co.nz

ashford
WHEELS & LOOMS